

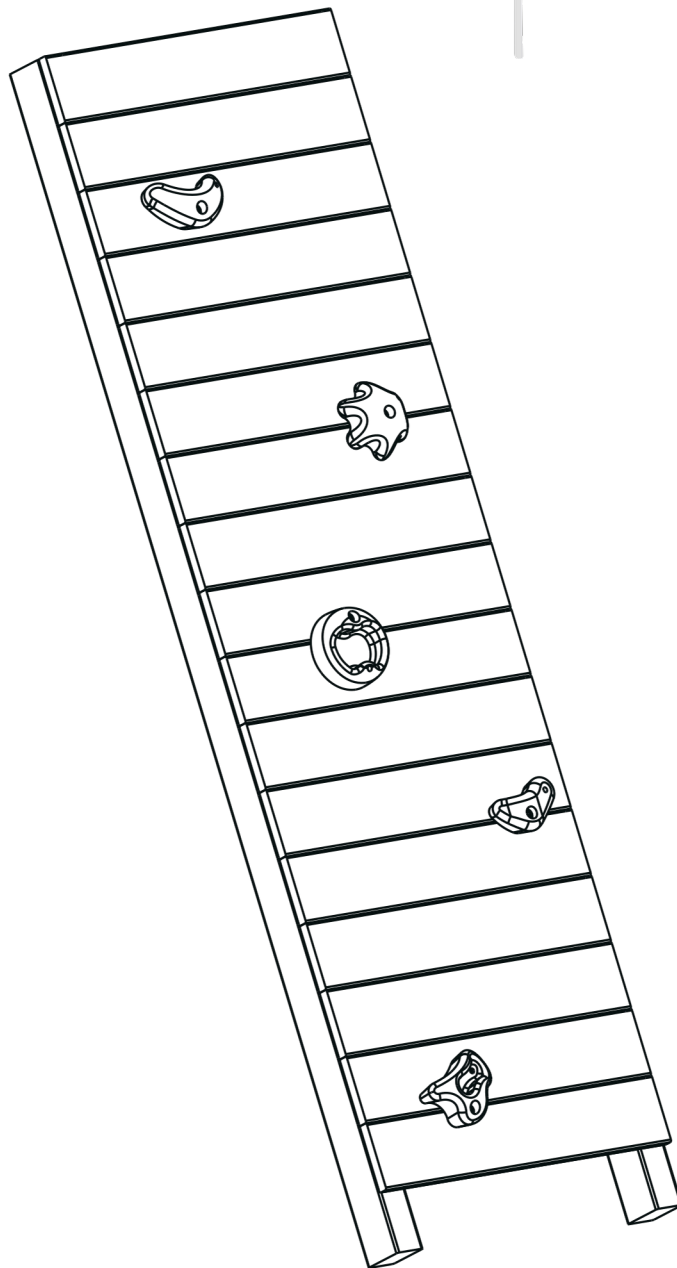

**blue rabbit**

- EN ASSEMBLY INSTRUCTIONS
- DE MONTAGEANLEITUNGEN
- FR INSTRUCTIONS DE MONTAGE
- ES INSTRUCCIONES DE MONTAJE
- IT ISTRUZIONI PER L'ASSEMBLAGGIO
- NL MONTAGE INSTRUCTIES



**blue rabbit 2.0**

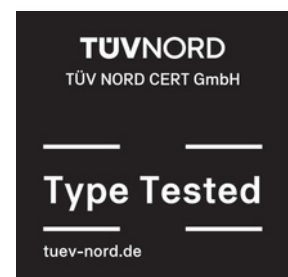

IM008.003.001-v05 (2025-08)



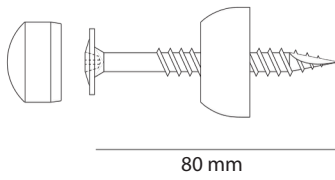
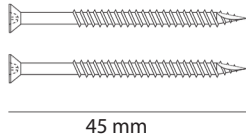
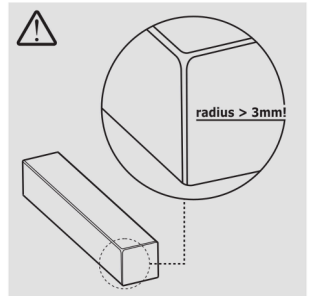
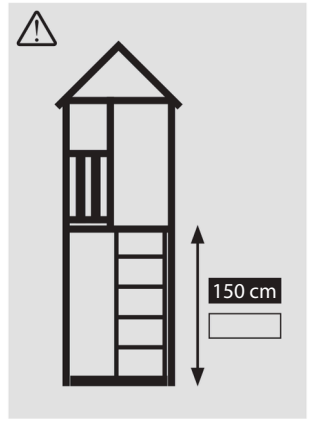
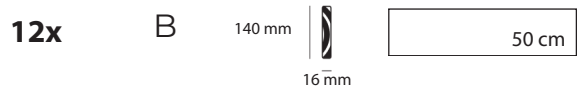

**5x**

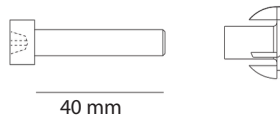

**5x**

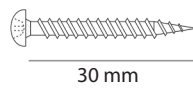

**5x**



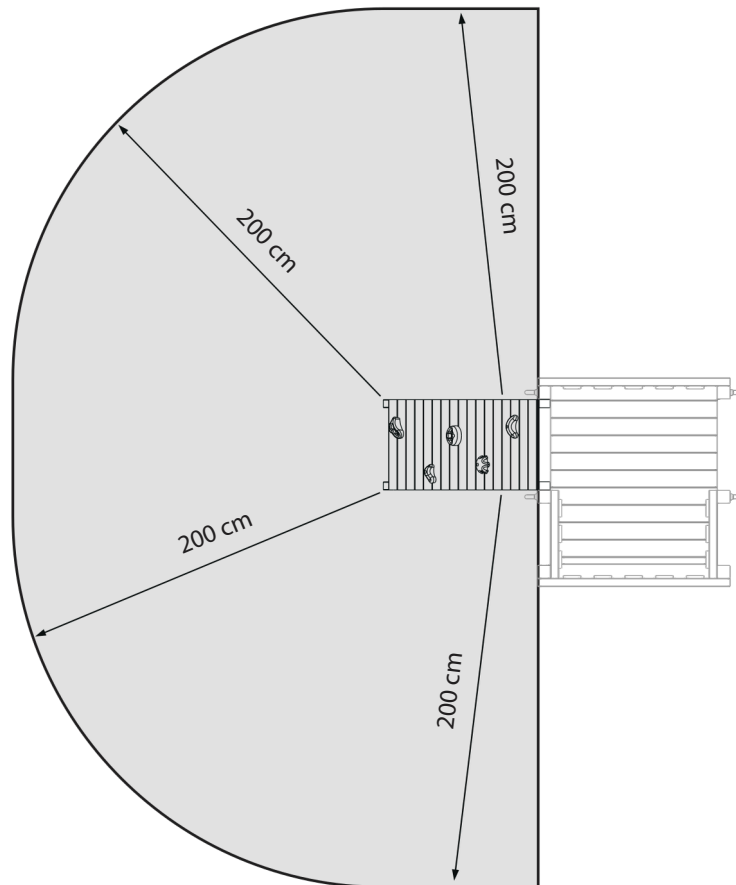
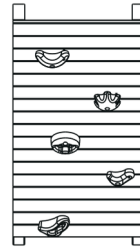
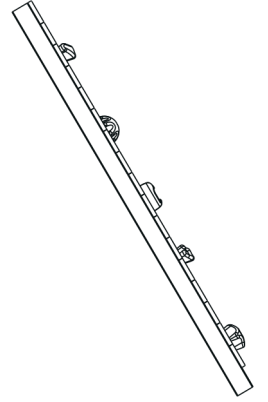
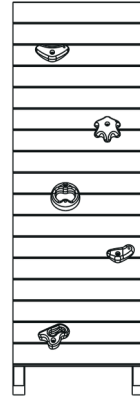
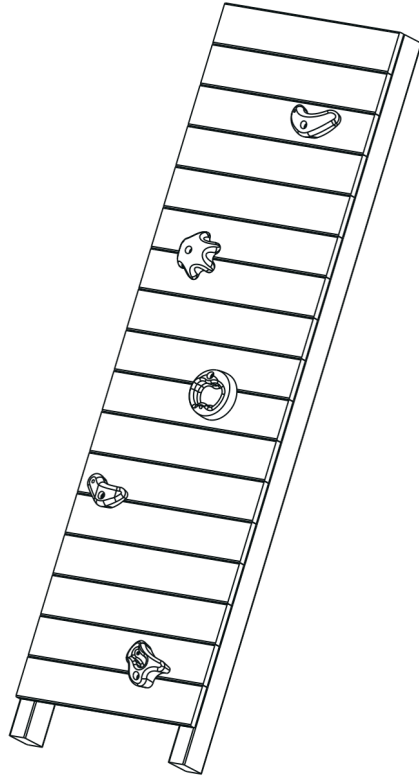

**TOOLS REQUIRED**

- (1) ratchet spanner
- (2) tape measure
- (3) pencil
- (4) drill and/or screwdriver
- (5) square
- (6) wood saw
- (7) hammer
  
- (8) bit torx TX20 and TX40
- (9) wood bore bits  $\varnothing$  3 mm and  $\varnothing$  5 mm
- (10) speed bore bits  $\varnothing$  10 mm and  $\varnothing$  28 mm
- (11) bit torx TX30

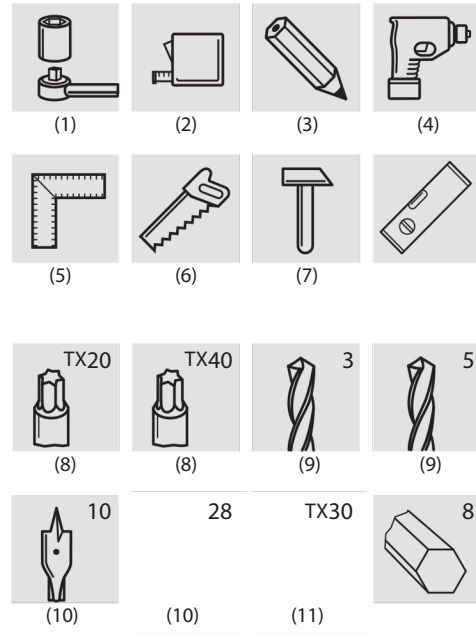

**WOOD SCREWS**

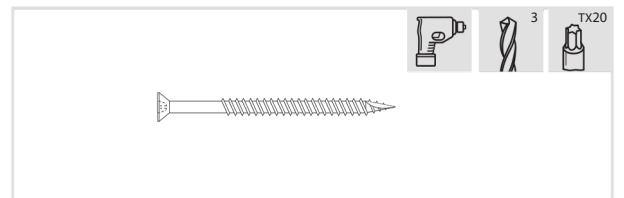

**COACH SCREWS**

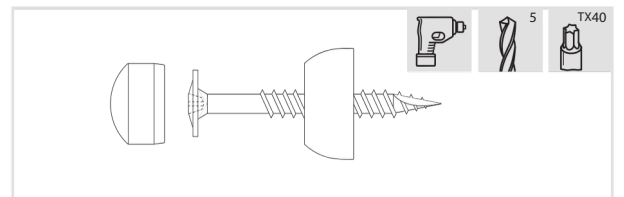

**BOLTED CONNECTIONS**

step 1/ Drill a hole with diameter 10 mm through both planks or beams that have already been screwed together (see 'wood screws')

step 2/ Hit the drive-in nut with a hammer along the designated side of the beam in the hole.

bolt turns smoothly in the press-in nut.

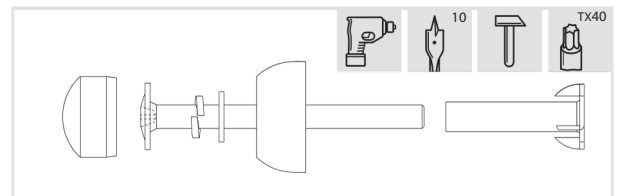

## DE MONTAGEANLEITUNGEN

### ERFORDERLICHES WERKZEUG

- (1) Universalschraubenschlüssel
- (2) Maßband
- (4) Bohr- und/oder Schraubmaschine
- (5) Winkelmass Holzäge Hammer
- (6) (7)
- (8) Bohrer Torx TX20 und TX40
- (9) Holzbohrer, Durchmesser 3 mm und 5 mm
- (10) Speedbohrer, Durchmesser 10 mm und 28 mm
- (11) Bohrer Torx TX30

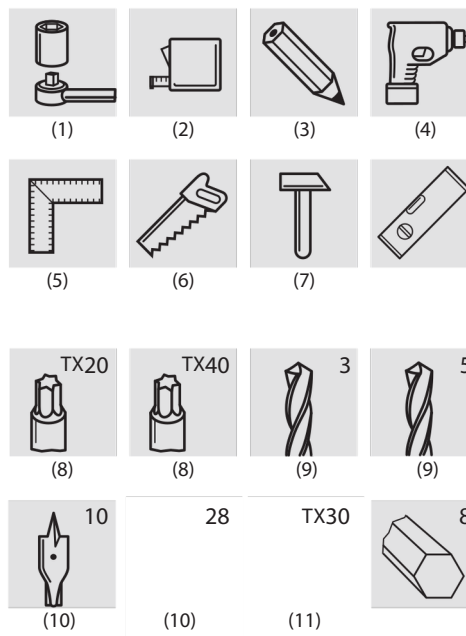

### HOLZSCHRAUBEN

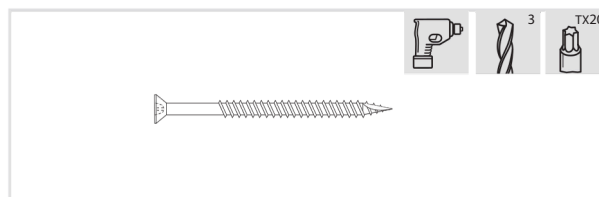

### VIERKANT-HOLZSCHRAUBEN

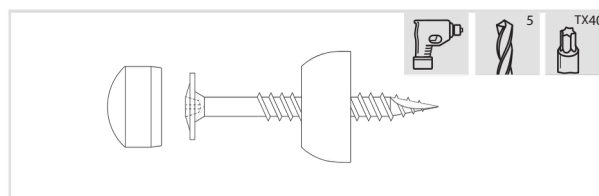

### SCHRAUBVERBINDUNGEN

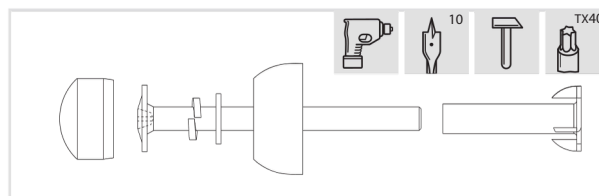

**OUTILLAGE NÉCESSAIRE**

- (1) clé à cliquet
- (2) mètre roulant
- (3) crayon
- (4) foreuse et / ou visseuse
- (5) équerre
- (6) scie à bois
- (7) marteau
  
- (8) tournevis torx TX20 et TX40
- (9) mèches à bois Ø 3 mm et Ø 5 mm
- (10) mèches foret Ø 10 mm et Ø 28 mm
- (11) tournevis torx TX30

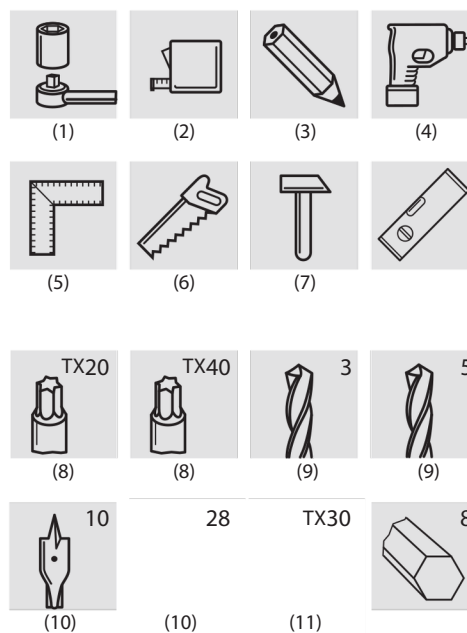

**VIS À BOIS**

étape 1/ Pour éviter que le bois ne se fende, nous conseillons de forer préalablement tout le bois à visser. La profondeur de forage doit être inférieure d'au moins 15 mm à la longueur de la vis. Les vis à bois de 4,5 mm de diamètre doivent être forées préalablement avec une mèche à bois de 3 mm.  
 étape 2/ Commencez par tourner la vis de quelques millimètres dans la planche à

que la tête de la vis soit au même niveau que le bois.

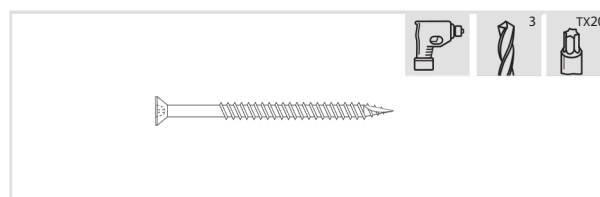

**TIRE-FOND**

étape 1/ Pour éviter que le bois ne se fende, nous conseillons de forer préalablement tout le bois à visser. La profondeur de forage doit être inférieure

de la vis.

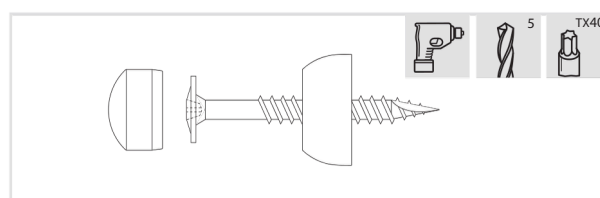

**BOULONS**

étape 1/ Forez un trou de 10 mm de diamètre à travers les deux planches ou poutres déjà vissées l'une à l'autre (voir « vis à bois »).

étape 2/ Enfoncez l'écrou à presser dans le trou avec un marteau, sur le côté désigné de la poutre.

presser.

étape 5/ Enfoncez le boulon avec le tournevis torx TX40 fourni, en tournant

boulon et la rondelle plate.

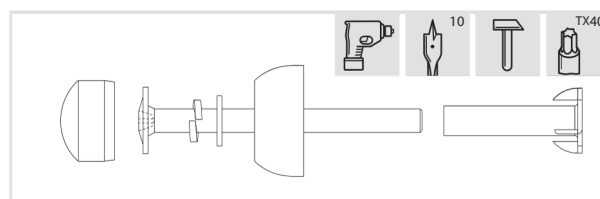

## HERRAMIENTAS NECESARIAS

- (1) llave de trinquete
- (2) cinta de medida
- (3) lápiz
- (4) taladro y/o destornillador
- (5) escuadra
- (6) sierra para madera
  
- (8) llave torx TX20 y TX40
- (9) brocas para madera de  $\varnothing$  3mm y  $\varnothing$  5 mm
- (10) brocas para taladro de alta velocidad de  $\varnothing$  10 mm y  $\varnothing$  28 mm
- (11) llave torx TX30

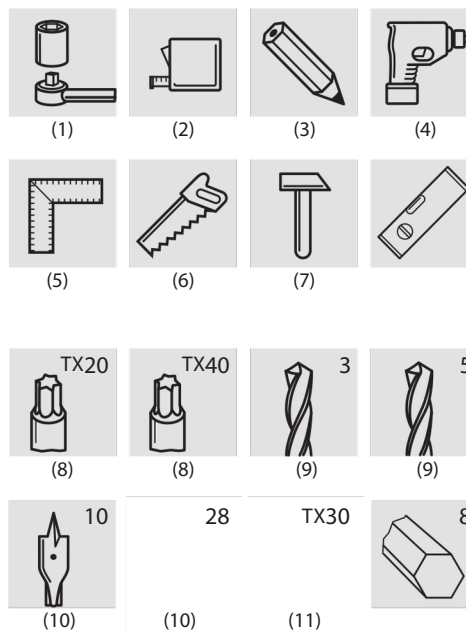

## TORNILLOS PARA MADERA

paso 1/ Para evitar que la madera se abra es recomendable hacer taladros

menos 15 mm menos profundos que la longitud del tornillo. Para los tornillos para madera de 4,5 mm, deben hacerse taladros con una broca para madera de 3 mm.

paso 3/ Apriete el tornillo con la llave torx TX20 que se suministra, hasta que la

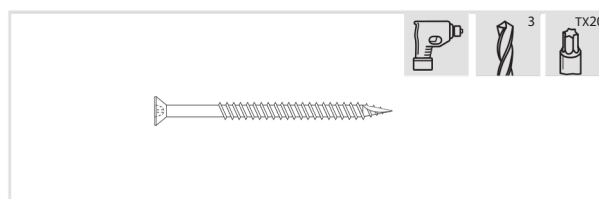

## TIRAFONDOS

paso 1/ Para evitar que la madera se abra es recomendable hacer taladros

de 8 mm, deben hacerse taladros con una broca para madera de 5 mm.

paso 2/ Inserte la arandela plana y la parte inferior de la cubierta protectora en el

paso 4/ Apriete el tornillo con ayuda de la llave torx TX40 que se suministra.

previsto para ello.

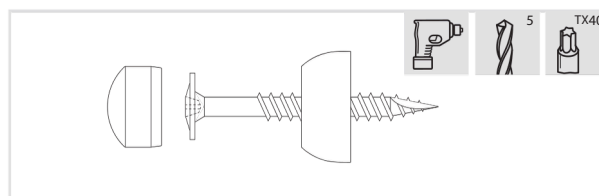

## TORNILLOS DE PUNTA PLANA

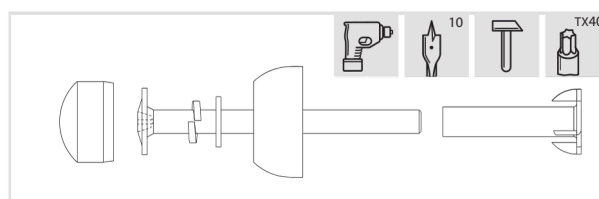

STRUMENTI DA LAVORO NECESSARI

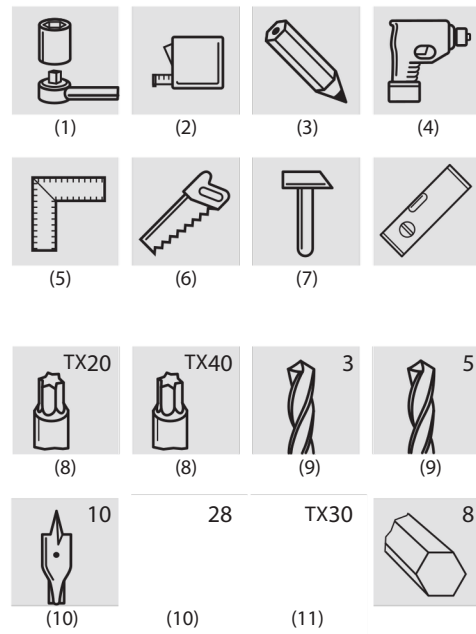

VITI DA LEGNO

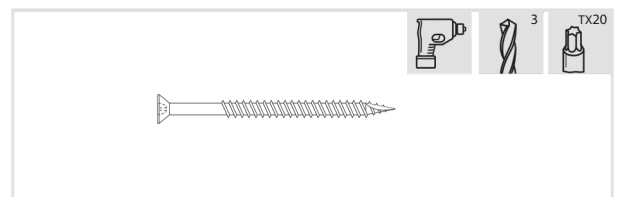

TIRAFONDO

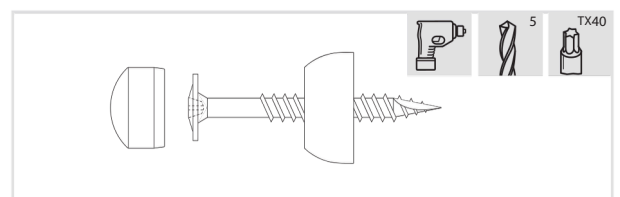

BULLONI

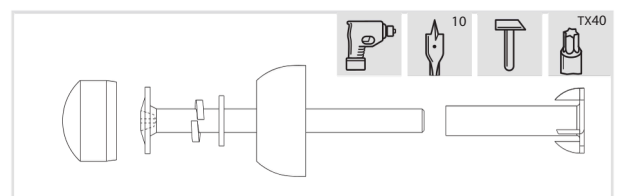

## BENODIGD GEREEDSCHAP

- (1) ratelsleutel
- (2) rolmeter
- (3) potlood
- (4) boormachine en/of vijsmachine
- (5) winkelhaak
- (6) houtzaag
- (7) hamer
  
- (8) bit torx TX20 en TX40
- (9) houtboren  $\varnothing$  3 mm en  $\varnothing$  5 mm
- (10) speedboren  $\varnothing$  10 mm en  $\varnothing$  28 mm
- (11) bit torx TX30

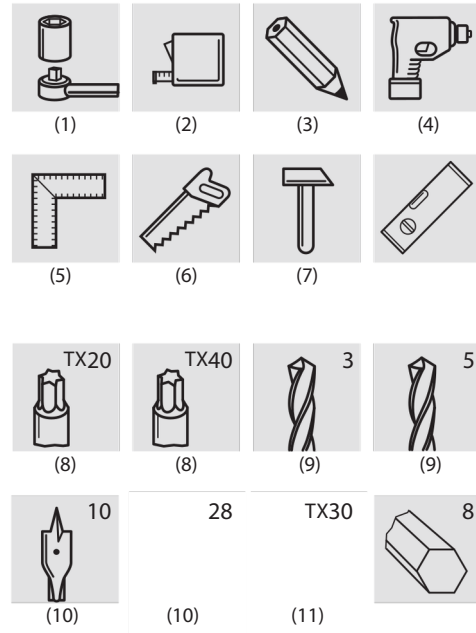

## HOUTSCHROEVEN

stap 1/ Om te vermijden dat het hout splijt raden wij aan alle te schroeven hout voor te boren. Boor steeds minstens 15 mm minder diep dan de schroef lang is. Houtschroeven diameter 4,5 mm boort U voor met een houtboor van 3 mm.

druk deze daarna stevig tegen het andere hout.

stap 3/ Draai de schroef met bijgeleverde bit torx TX20 in het hout tot de kop van de schroef gelijk komt met het hout.

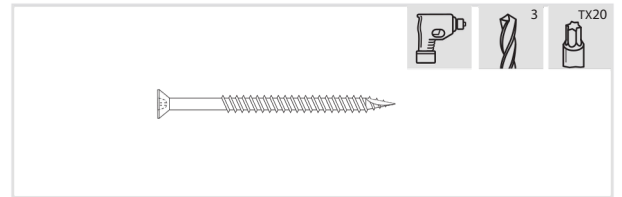

## HOUTDRAADBOUTEN

stap 1/ Om te vermijden dat het hout splijt raden wij aan alle te schroeven hout voor te boren. Boor steeds minstens 15 mm minder diep dan de schroef lang is. Houtdraadbouten diameter 8 mm boort U voor met een houtboor van 5 mm.  
 stap 2/ Plaats de vlakke sluitring en het onderste deel van de afdekdop over de schacht van de schroef.

deze daarna stevig tegen het andere hout.

stap 4/ Draai met bijgeleverde torx bit TX40 de schroef aan.

stap 5/ Druk het kapje van de afdekdop in de voorziene opening.

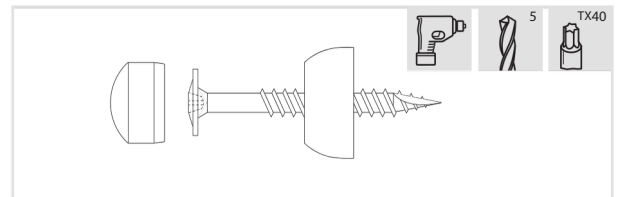

## BOUTVERBINDINGEN

stap 1/ Boor een gat met diameter 10 mm doorheen beide reeds aan elkaar geschroefde planken of balken (zie 'houtschroeven')

stap 2/ Sla de inslagmoer met een hamer langs de aangeduide zijde van de balk in het gat.

stap 3/ Plaats de veerring, de vlakke sluitring en vervolgens het onderste deel van de afdekdop over de schacht van de bout.

stap 4/ Schuif de bout door het gat, en draai met de hand enkele toeren tot de bout vlot in de inslagmoer draait.

stap 5/ Draai met bijgeleverde torx bit TX40 de bout aan, tot de veerring volledig is platgedrukt tussen de kop van de bout en de vlakke sluitring.

stap 6/ Druk het kapje van de afdekdop in de voorziene opening.

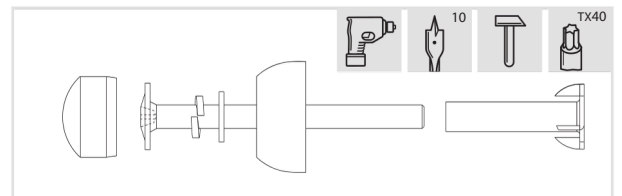

- A 2x
- B 1x
-  2x

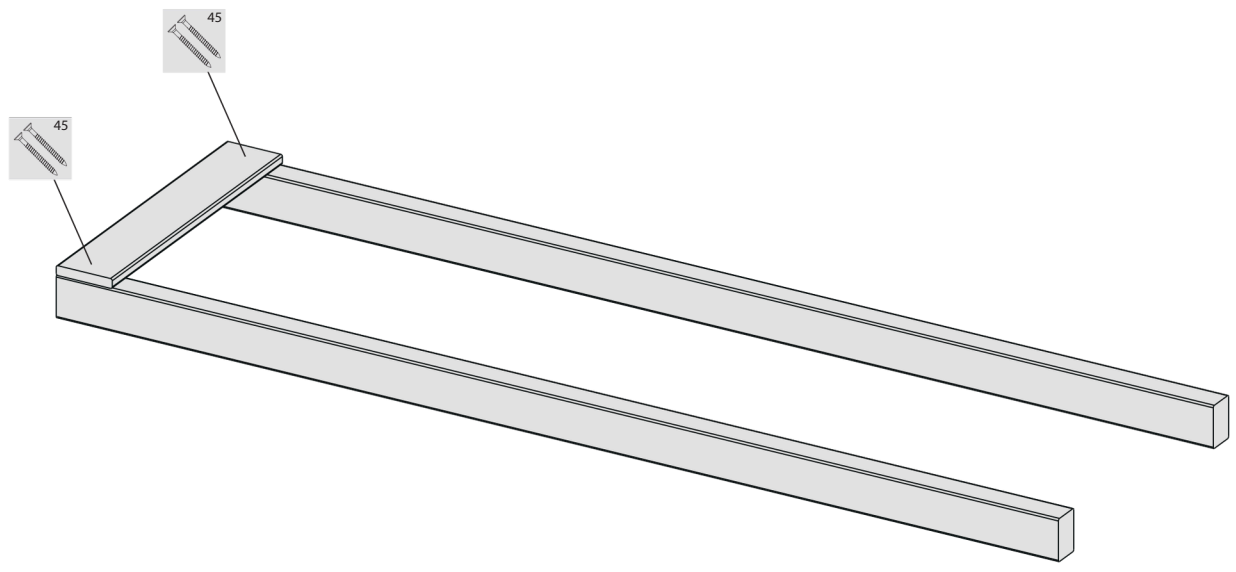

1a

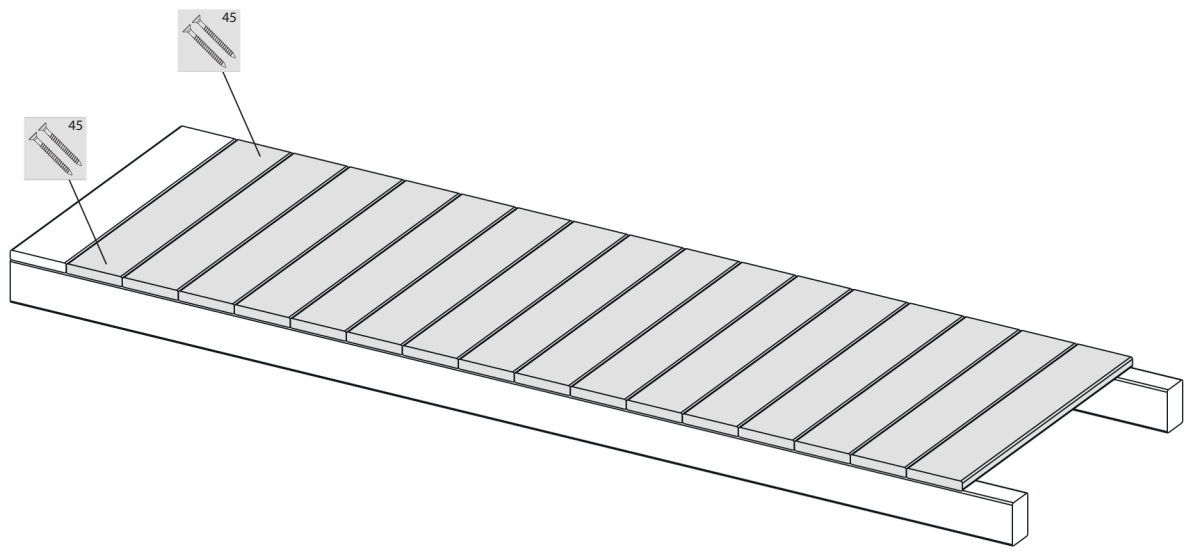

- B 8x/16x
-  32x

1b



-  **1x**
-  **1x**
-  **1x**

**2a**

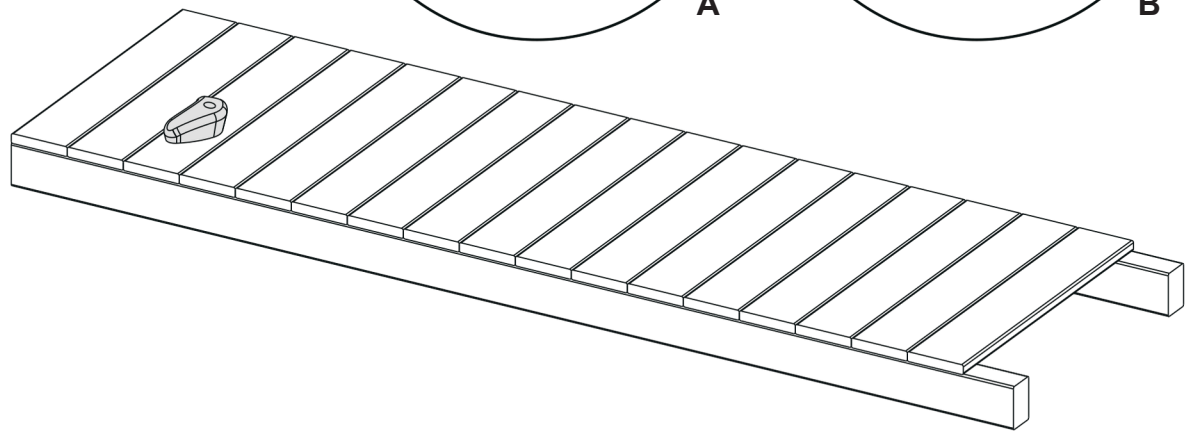
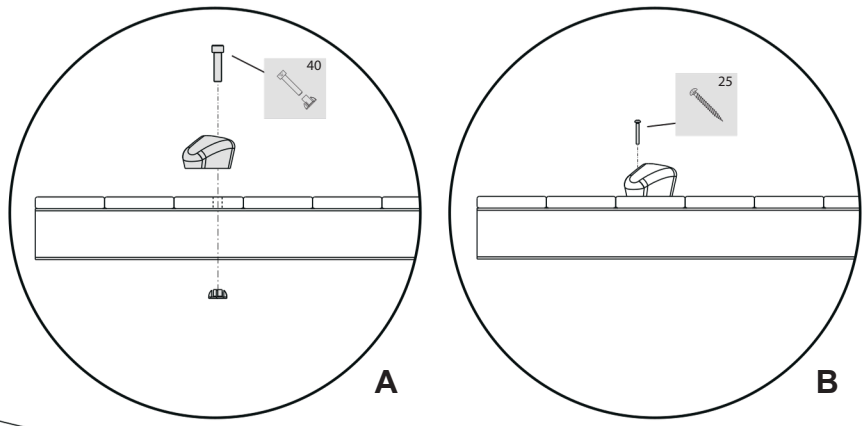

-  **4x**
-  **4x**
-  **4x**

**2b**

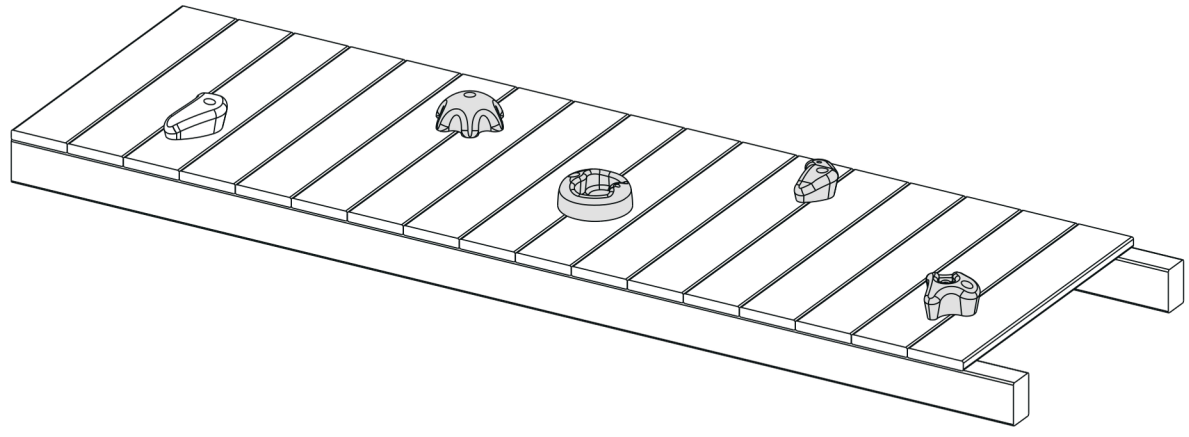

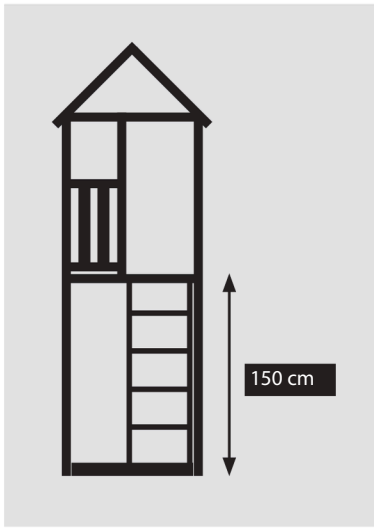

1

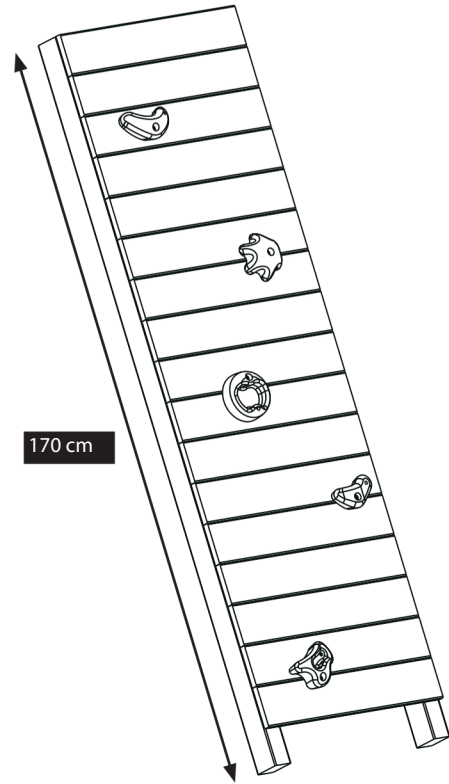



2x

